

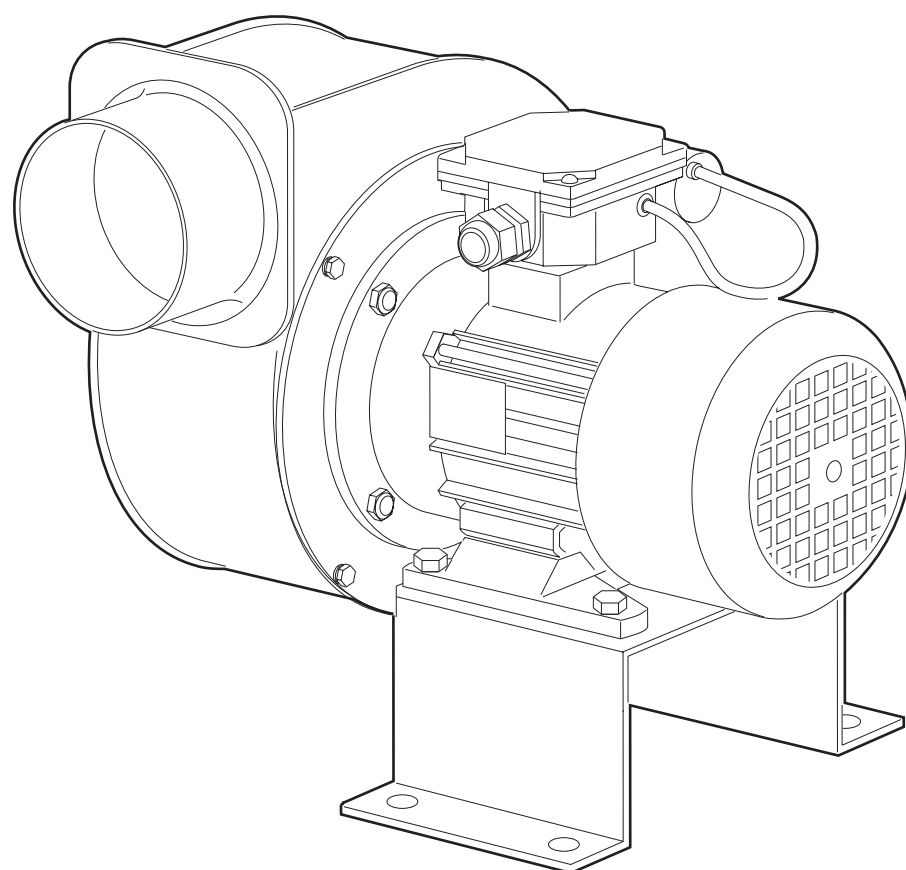

C 600



CONTENT

1 General	2
2 Manufacturer	2
3 Technical data	2
4 Warranty	2
5 Safety	2
6 Installation	3
7 Start of operation	3
8 Maintenance	3
9 Spare parts list	3
10 Manufacturer Declaration	3

1 General

The manual should always be available for the operating personnel. The instructions should be carefully read before installation and operation of the fan. If strict notice is taken of these instructions, the fans run with trouble-free operating for years.

With reservation for the right to make alterations. If doubtful, get in touch with the manufacturer.

2 Manufacturer

FUMEX AB Verkstadsvägen 2
Tfn: +46 (0)910-361 80 S-931 61 Skellefteå
Mail: info@fumex.se Sweden

3 Technical data

Following data is for the fan in its basic form, however, delivered fan can differ from the basic form. See the markings or the text "Special execution". Blowers of type C 600 have casing of powder coated steel sheet and impeller in sheet steel. Impeller have forward curved blades of type "F" which may only convey clean gas. Any possible solid particles or other pollutions must be filtered before they enter the fan.

The temperature of the conveyed medium may not exceed 80°C. It is not permitted to use the fan in surroundings where the temperature exceeds 40 °C or goes below -20 °C. Conveying of explosive gases is not permitted. It is not permitted to rebuild or in any other way modify the fan. Special features that can be used in other surroundings than above can be offered on request and clarification with the manufacturer.

3.1 Marksign

When connecting, maintenance or ordering of spare parts, pay attention to data on the mark sign in first instance.

3.2 Special execution

Temperature barrier, EEx motors, housing and impeller in other materials, can be delivered on request and after clarification with the manufacturer.

4 Warranty

Warranty is valid in accordance with General Conditions Orgalime S2012 and only if these instructions are strictly adhered to.

5 Safety

Following safety instructions must be carefully followed with regard to preventing injury or damage to surrounding equipment and to the fan itself.

5.1 Suction



Centrifugal fans have high suction power. Objects, clothing and hair can easily be sucked into the fan and cause injury. Make sure that there are no persons nearby the inlet side when the fan operates. The fan must never operate without a wire guard because the rotation impeller can cause serious injury. Never put the hand directly at the inlet opening.

5.2 Discharge side



There is a powerful stream of air from the discharge side. Foreign bodies that might have been sucked into the fan can be thrown out at high speed and cause injury. Never put the hand directly at the discharge opening.

5.3 Temperature



When the fan operates the fan housing takes the temperature of the conveyed media added to the compression heat. If the fan housing temperature exceeds 50 °C the fan must be protected from direct contact to prevent burn injury.

5.4 Electrical connection



Electrical connection must be made by skilled labour only. The drive motor should be protected with an overload switch.

5.5 Permitted applications



Fans are not to be used for conveying aggressive, toxic or air with high humidity or gas or explosive air-gas mix. Any possible solid particles or other pollutions must be filtered before they enter the fan. The temperature of the conveyed medium may not exceed 80 °C.

5.6 Sound level

The sound pressure level is not the same over the fans whole range. In some cases it is necessary to use a silencer. We recommend the user to check the sound pressure level.

6 Installation

6.1 Transport

Check all parts for damage during transportation and that the impeller runs free inside the housing. The fans are to be installed in weather-protected places and are not to be stored outdoors unprotected. Mount hoisting hook carefully, and do only use lifting arrangements with sufficient strength.

6.2 Arrangements and assembling

Mount the fan horizontally or vertically in a weather-protected place. Make sure that the fan is protected from vibration and shock. Supply open inlet and discharge openings with guards according to valid regulations. Also make sure that the drive motor is supplied with sufficient ventilation. The permitted maximum temperature of surroundings is 40 °C.

6.3 Electrical connection



The operations described in this part are to be made by skilled labour only. Connect the fan in accordance with the **Wiring diagram** (page 4) in the terminal box. The respective VDE regulations and the directions of the local power supply company are to be complied with.

The fan is equipped with a drive motor for single- or three-phase AC. The motor should be protected with an overload switch. Connection to earth is to be found in the terminal box. See last page for connection drawing.

6.4 Inspection of rotation direction

Start up the fan for a short moment, inspect the rotation direction. The rotation direction of the impeller must be in accordance with the arrow on the motor. If not, move the L1 and L3 phases for three-phase operation or check

the wiring circuit in the terminal box for single-phase operation. Incorrect rotation direction will cause reduced capacity of the fan and could damage the impeller.

7 Start of operation

If the rated current indicated on the rating plate is being exceeded during operation, it should be checked whether the available supply voltage and frequency are in accordance with the embossed data.

Installation of thermal protection is recommended preventing overheating. Overloading can be avoided through installation of relief valve which will keep the maximum allowed working point. Do not expose the fan to vibrations and shock.

8 Maintenance

Fans are equipped with enclosed grooved ball bearings that do not need lubrication. The grease filling is sufficient for the whole service life of the bearings.



Repair work on fans should be done by the manufacturer. We do not take any responsibility for repairs done by third parties.

9 Spare parts list

When ordering spare parts, please state the size of the fan and part number in accordance with the **Exploded view/Spare parts** (page 4).

10 Manufacturer Declaration

We certify that the product to which this certificate relates is in conformity with the standards or standard setting documents listed below. If a modification of the unit is made without our approval, this declaration becomes invalid



Relevant regulations and standards to which this product corresponds:

- Machinery directive 2006/42/EG
- EMC-Directive 2014/30/EU
- EN ISO 12100:2010
- EN 60204-1

Starting operation of this machinert part is not allowed as long as it is not assembled into the main installation respectively not all necessary safety devices have been installed which fulfil the requirements of the EC directive for machines with regard to safety and health.

Mounting

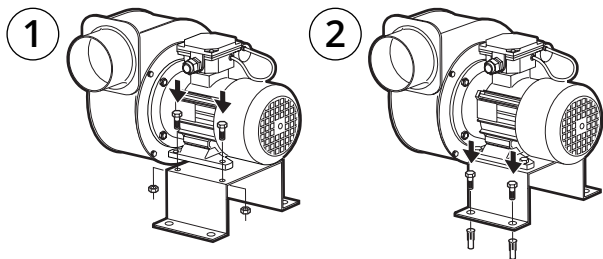

Versions

The fan is available as standard in the following versions (inlet side view):



 Standardised form of delivery.

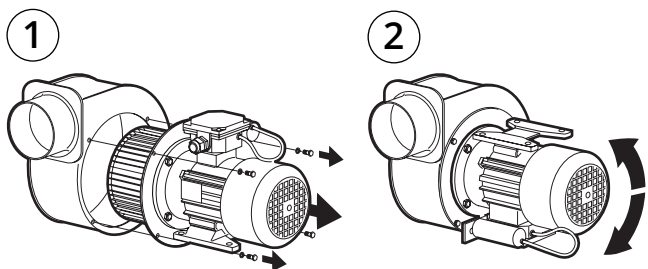

Installation

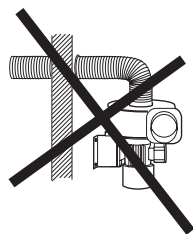
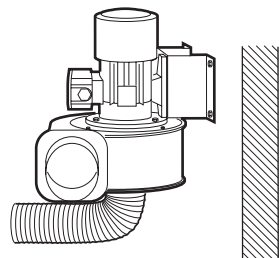
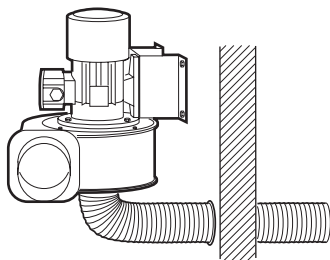

Wiring diagram

Three-phase AC unit:

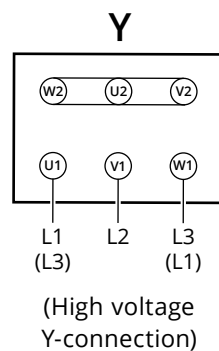
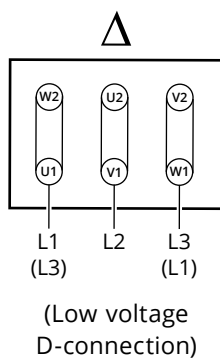

Single-phase AC unit:

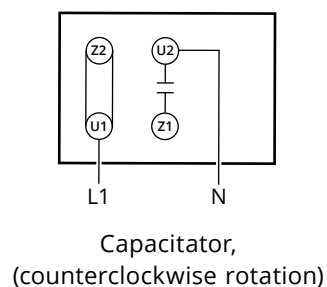
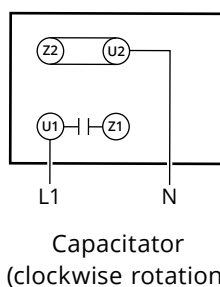

Exploded view/Spare parts

